

Miele®

Operating Instructions for the S 280i Vacuum Cleaner

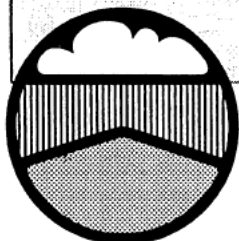
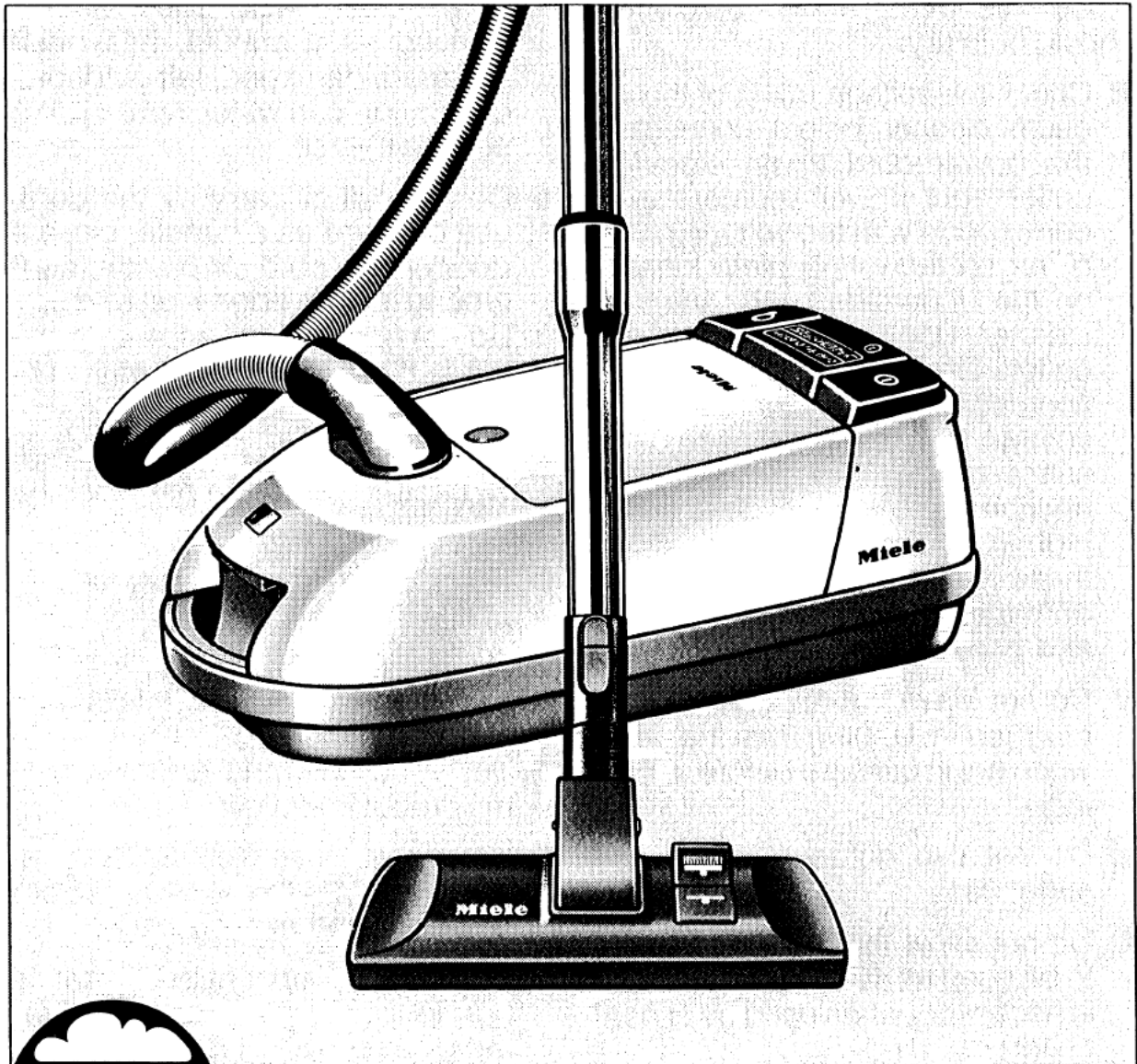

CARING FOR
THE ENVIRONMENT

This paper is manufactured from straw cellulose. Straw is a natural agricultural residue from cereal production and its use in paper helps to save more trees.

USA

T.-Nr. 3650261/02

IMPORTANT SAFETY INSTRUCTIONS

When using an electrical appliance, basic precautions should always be followed, including the following:

READ ALL INSTRUCTIONS BEFORE USING THIS APPLIANCE

WARNING -

To reduce the risk of fire, electric shock, or injury:

- Check the voltage rating of the vacuum cleaner before connecting the power cord to an electrical outlet. Your power source should correspond with the voltage rating given on the rating plate located on the underside of the vacuum cleaner. Use only household AC outlets. Never use DC power sources. If you are unsure of the voltage supply in your area, consult a qualified electrician. Connection of the vacuum cleaner to a higher voltage than indicated in these instructions may result in damage to the vacuum cleaner and personal injury.
- Do not leave the appliance when plugged in. Unplug from the outlet when not in use and before servicing.
- Do not use outdoors or on wet surfaces.
- Do not allow the vacuum cleaner to be used as a toy. Close attention is necessary when used by or near children.
- Use only as described in this manual. Use only manufacturer's recommended attachments.
- Do not use with damaged cord or plug. If the appliance is not working as it should, has been dropped, damaged, left outdoors, or immersed in water, return it to a service center.
- Do not pull or carry by the cord, use the cord as a handle, close a door on the cord, or pull the cord around sharp edges or corners. Do not run the appliance over the cord. Keep the cord away from heated surfaces.
- Do not unplug by pulling the cord. To unplug, grasp the plug, not the cord.
- Do not handle the plug or appliance with wet hands.
- Do not put any objects into the openings. Do not use with any opening blocked; keep free of dust, lint, hair, and anything that may reduce air flow.
- Keep hair, loose clothing, fingers, and all parts of the body away from openings and moving parts.
- Do not pick up anything that is burning or smoking, such as cigarettes, matches, or hot ashes.
- Do not use without the dustbag and/or filters in place.
- Turn off all controls before unplugging.

- Use extra care when cleaning on stairs.
- Do not use to pick up flammable or combustible liquids, such as gasoline, or use in areas where they may be present.
- When using this appliance in conjunction with a motorized nozzle and a current-carrying hose:
 - The hose contains electrical wires. Do not use if damaged, cut, or punctured. Avoid picking up sharp objects.
 - Always turn off this appliance before connecting or disconnecting either the hose or the motorized nozzle.
- This appliance is equipped with a power cord reel:
 - Hold the plug when rewinding onto the cord reel. Do not allow the plug to whip when rewinding.
- When using this appliance in conjunction with the Turbobrush:
 - Always unplug before connecting.
- Use only attachments specified by the manufacturer. Do not use the blower to operate paint sprayers or similar devices that emit volatile or toxic vapors.
- The vacuum cleaner shuts off automatically by thermostatic control if it overheats. Overheating could be due to a clogged hose, a heavily soiled dust compartment or exhaust filter, or a full dustbag. If this occurs, rectify the problem and wait about 15 minutes for the motor to cool down. The vacuum cleaner can then be switched on again.
- Do not switch on or attempt to operate the vacuum cleaner unless a dustbag and dust compartment and exhaust filters are in place. Use only genuine MIELE double-layer dustbags and filters (see 'Maintenance' for instructions on how to insert the dustbag and filters). If no dustbag has been inserted, the dust compartment cover cannot be closed.

DO NOT USE FORCE!

WARNING:

Electric shock could occur if the vacuum cleaner is used outdoors or on wet surfaces.

- Always switch off the vacuum cleaner and disconnect the plug from the wall outlet before servicing (see 'Maintenance'). Do not attempt any other repairs. Other servicing should be performed by an authorized Service Agent.
- Protect your vacuum cleaner from heat and moisture. Store in a cool, dry place, away from children and household traffic.

SAVE THESE INSTRUCTIONS

THIS APPLIANCE IS INTENDED STRICTLY FOR HOUSEHOLD USE ONLY

Description of the appliance

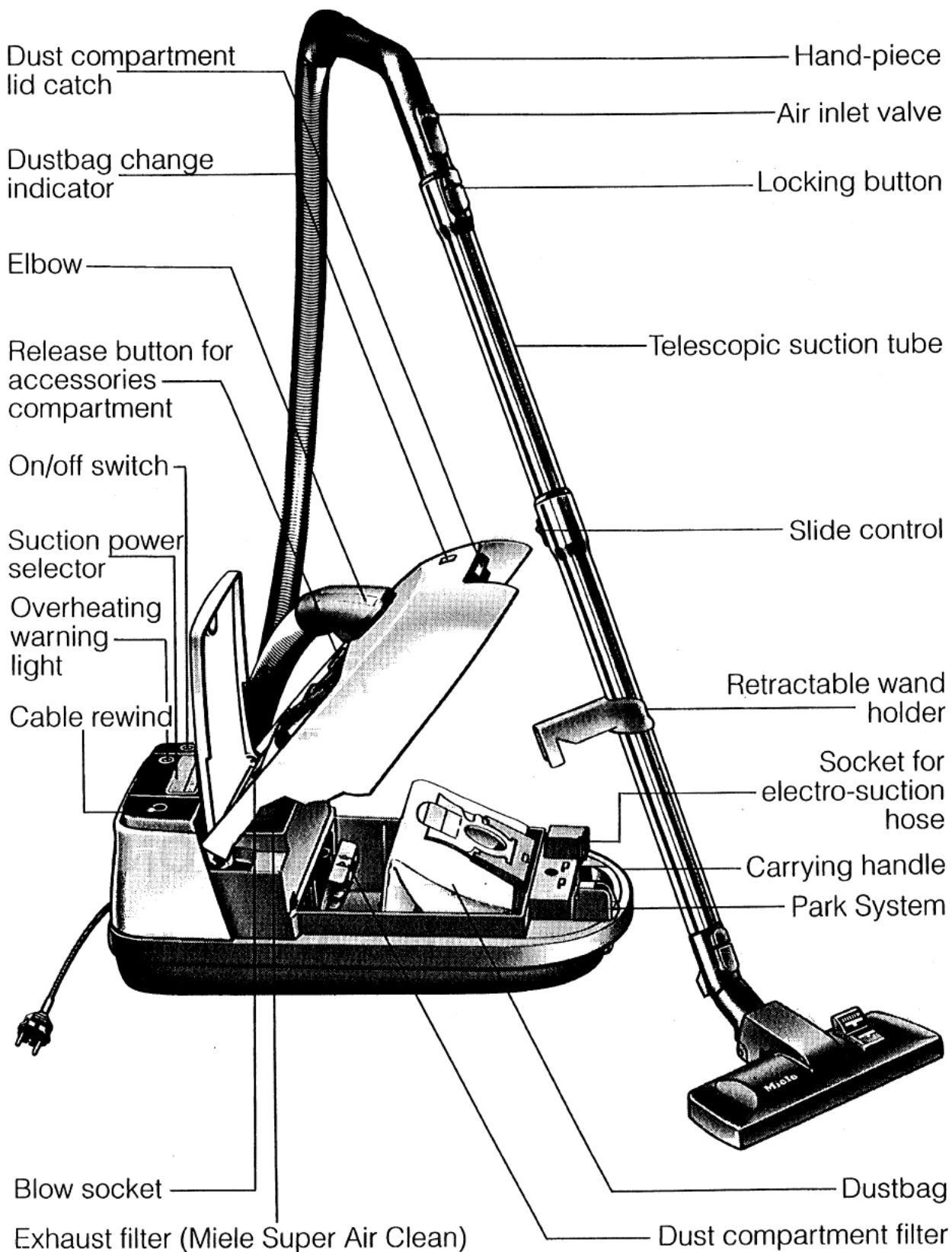

Assembling the vacuum cleaner

Connecting the suction hose to the vacuum cleaner

- Insert the “elbow” hose coupler into the suction opening, as shown, until it snaps into position.
- To disconnect the hose from the vacuum cleaner, press the locking button on the “elbow” and lift out of the suction opening.



NOTE: The suction hose may be connected to the exhaust end of the vacuum cleaner to be used as a blower and also to unclog the hose, wand, etc.

- Open tool caddy.
- Connect hose “Elbow” and move filter cover to the left.

After Completion of the blowing operation:

- Remove hose “Elbow”.
- Close tool caddy. The filter will be opened automatically.

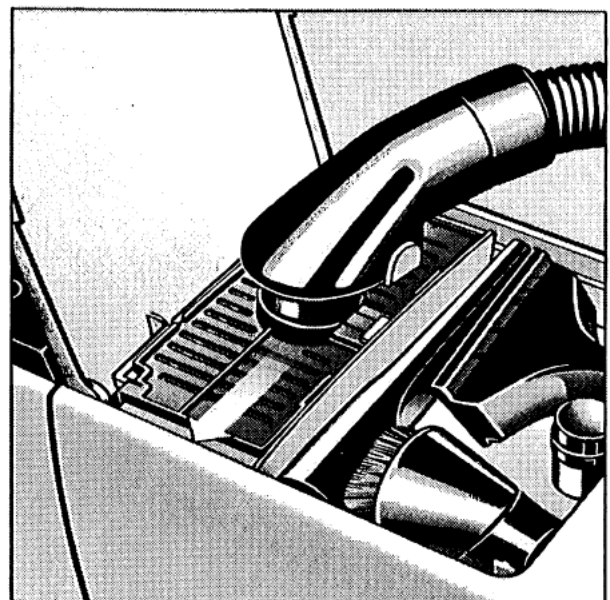

Assembling the vacuum cleaner

For very intensive blowing action use the enclosed blower plate.

- Important: Close the tool caddy first and then open it. This ensures that the exhaust grille is in the proper position.
- Open dust compartment lid and remove the Miele Air Clean Filter.
- Insert the blower plate and close dust compartment lid.

After use as a blower replace the Miele SUPER Air Clean Filter!

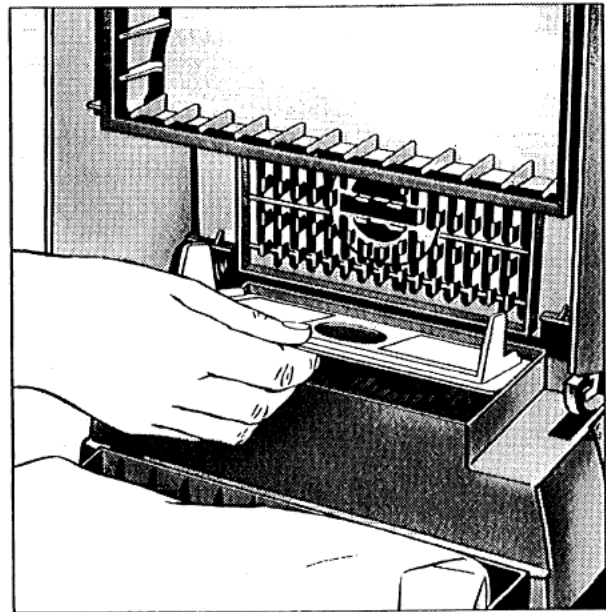

Assembling the vacuum cleaner

Connecting the telescopic suction wand to the suction hose

- Slide the hand grip of the suction hose into the telescopic wand until it "clicks" into place, as shown.
- Fit the hand-piece of the suction hose firmly together with the suction wand.
- To release the hand-piece from the suction wand, press the locking button (see arrow).

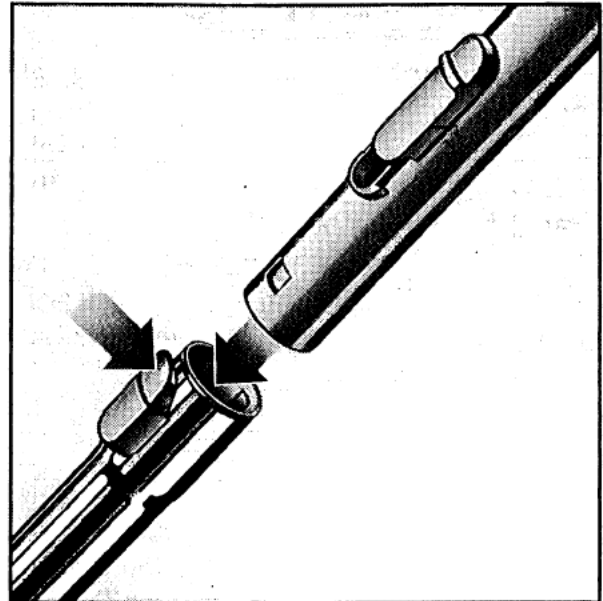

Adjusting the telescopic wand

The telescopic wand has two interconnected parts that can be adjusted to suit your height for convenient vacuum cleaning.

To adjust:

- Bring the adjuster control upwards, or press downwards and adjust the suction tubes to the required length.

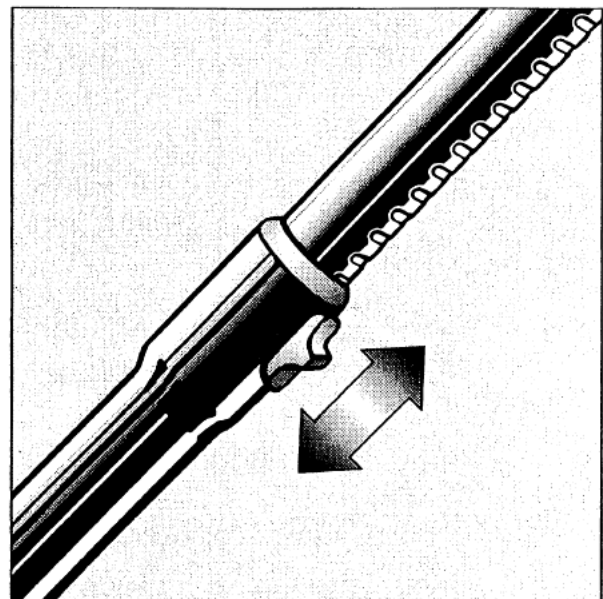

Assembling the vacuum cleaner

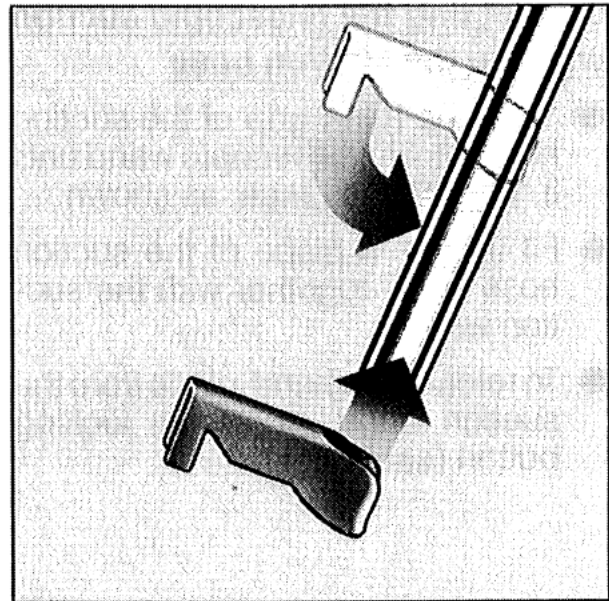

Telescopic Wand Holder

Before attaching the floor nozzle, attach the retractable wand holder to the telescopic suction wand and fold down. In the unfolded position, the wand holder allows the entire wand (including nozzle) to be attached by placing the holder into the receptacle on the canister. This allows for easy transportation and storage.



Attaching the floor nozzle or Turbo-brush

The **floor nozzle** is recommended for routine cleaning of rugs, carpeting and bare flooring such as parquet, tile, linoleum or stone.

- Fit the telescopic suction wand into the circular opening of the floor nozzle, as shown by the arrow. The floor nozzle must lock into place securely.
- To release the floor nozzle from the suction wand, press the locking button.
- The floor nozzle can be adjusted to conform to the type of flooring to be cleaned.
- To clean bare floors, depress symbol . The brush is now protruding.
- To clean rugs and carpeting, symbol  should be depressed. This retracts the brush.

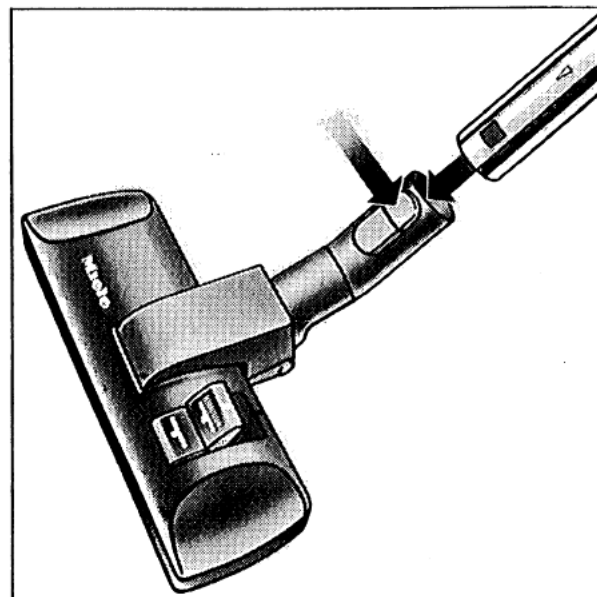

Standard accessories

Each vacuum cleaner features as standard equipment a three-piece set of accessories designed to meet a variety of cleaning requirements.

- Crevice tool
- Upholstery nozzle
- Dusting brush

All three accessories can be fitted onto the hand grip or used with the telescopic suction wand for additional cleaning reach.

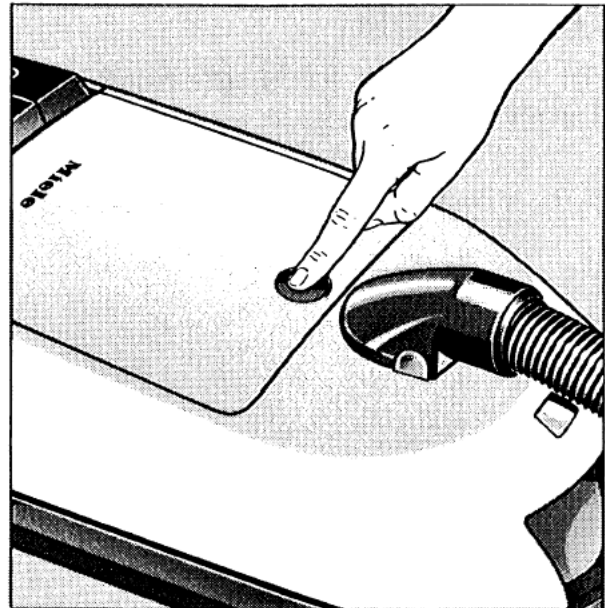

The accessories are conveniently located in a recessed storage caddy in the vacuum cleaner body.

- The tool caddy can be opened by depressing the release button on the dust compartment cover, as shown.

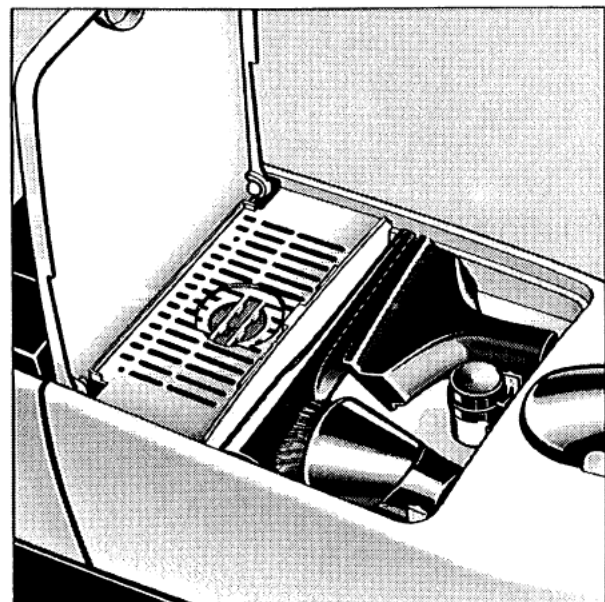

Standard accessories

Crevice nozzle

For cleaning in folds, crevices and corners.

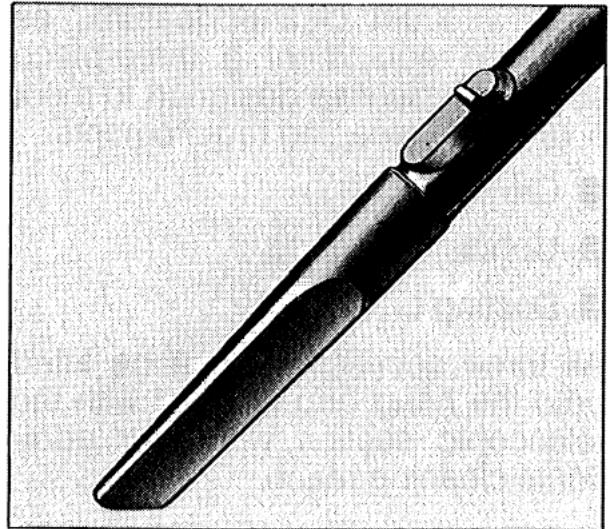

Upholstery nozzle

For cleaning upholstery, mattresses, cushions, curtains, clothing, etc.

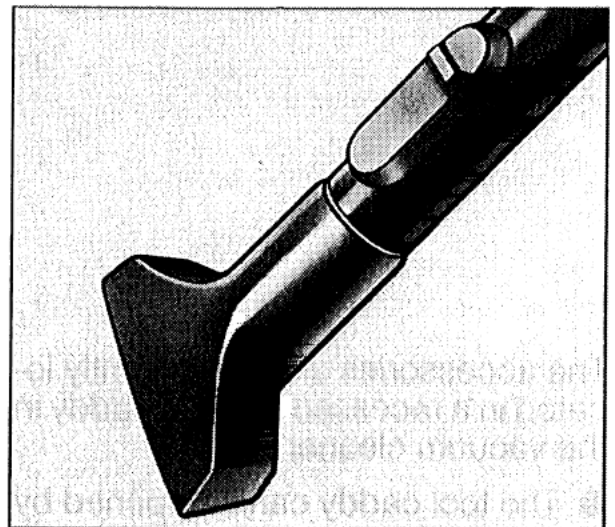

Dusting brush

For cleaning skirting boards, ornate or carved articles, etc.

The head of the dusting brush can be swivelled to attain the best cleaning position.



Turbo-brush S 021

Recommended for deep-cleaning and restoring crushed carpet pile on low-nap carpeting.

The turbobrush is fitted onto the telescopic suction wand and is mechanically driven by the suction power of the vacuum cleaner.



Floor Brush

For cleaning of hardwood floors, stone or PVC floors.



Cloth Dustbag

The cloth bag is easily emptied and shaken out by removing the pinch bar.

Do not wash dustbag this will restrict the capacity of the bag.

Both cloth and paper dustbags are available at your local Authorized Miele dealer.



Optional extras

Radiator Brush

For cleaning radiators, narrow shelves or crevices.

Fit the radiator brush onto the crevice nozzle.



Universal Brush

For dusting shelves, bookcases, etc.

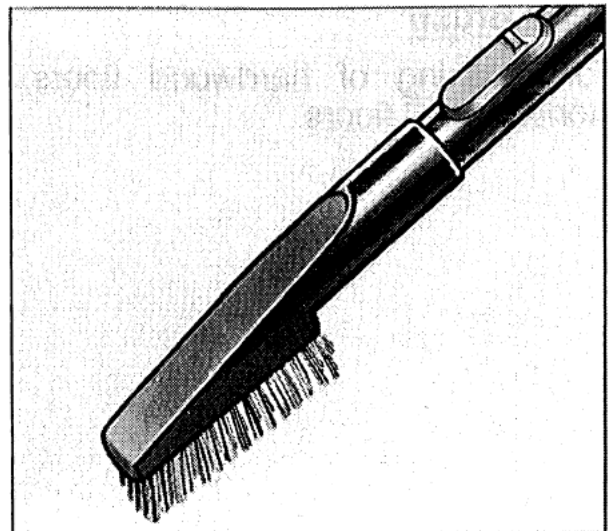

These and other fine Miele products, including the SEB 245 Electric Powerbrush are available at your local Authorized Miele Dealer.

Unwinding and rewinding the cable

Unwinding

- Hold the plug and unwind the cable to the required length (max. 21 ft.)



Rewinding:

Depress the rewind button, and the cord will automatically rewind. It is recommended that you guide the last few feet of the cable into the bin to prevent any whip effect.



Operation

Switching on and off

Depress foot switch to switch the vacuum cleaner on or off.

Selection Suction

The vacuum cleaner is equipped with an electronic suction selector.

By depressing the selector you can choose either the 5 manual settings on the automatic setting.

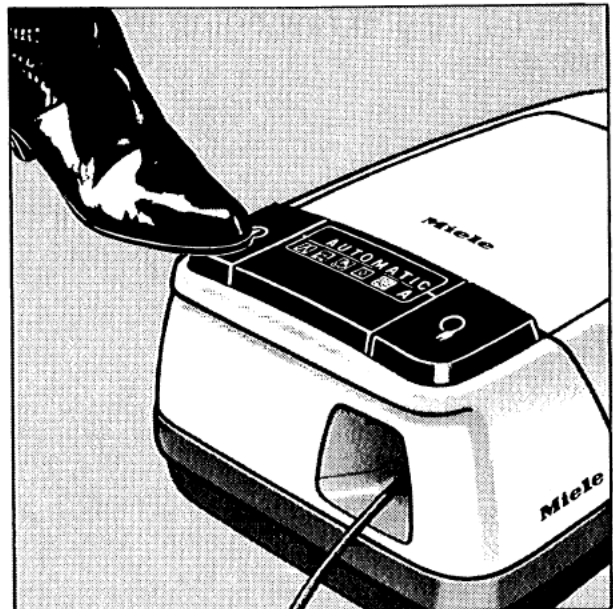

Automatic Suction Selector

When set on "A" for automatic the electronic suction power will automatically adjust to the various types of carpet piles.

- Depress the suction power selector with the foot until the required power setting appears in the indicator window.

Reducing the suction power reduces the amount of effort required for manoeuvring the cleaning attachment. By setting the suction regulator according to the degree of soiling and type of flooring being cleaned energy will also be saved.

The symbols on the suction power selector are an indication of the correct setting of the suction regulator.

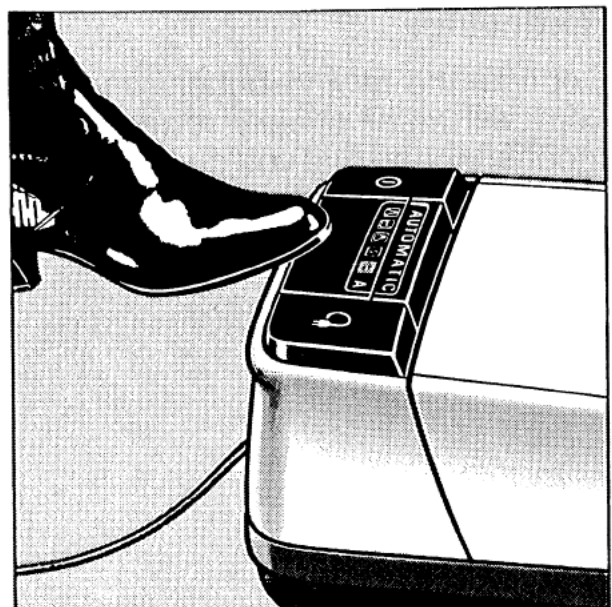





When in “automatic” suction mode, the air inlet valve must remain closed – otherwise the electronic suction regulation does not function properly.

Manual Suction Settings

The vacuum also has 5 different manual suction settings.

Below are the symbols as they appear on the suction selector:

-  = Drapes, Textiles
 -  = Furniture, Pillows
 -  = Energy saving, daily cleaning
 -  = Quality carpeting, Orientals rugs
 -  = Hardwood floors, deep-cleaning of carpeting & floors.
- A = Suction automatically adapts to the various carpet piles and floors.

Operation

Suction regulator (Air inlet valve)

For quick and easy reduction of suction power, as needed when cleaning curtains, drapes and light-weight area rugs:

- To avoid rugs, drapes, etc., from getting sucked up.
- Only open the suction regulator until the suction nozzle can be easily moved.

Opening the air inlet valve reduces the amount of effort and suction required for manoeuvring the cleaning attachment being used.

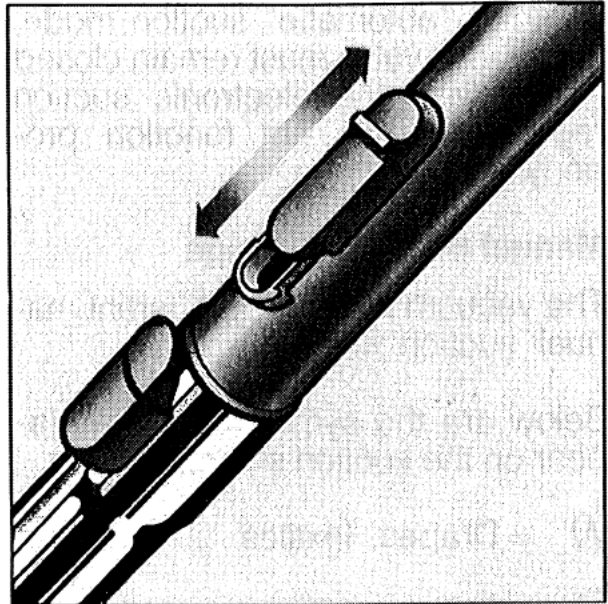

Dustbag change indicator

This indicates when the dustbag needs changing.

Set the suction power selector to maximum.

When the red mark on the dustbag change indicator covers the window completely, change the dustbag, even if it does not seem completely full.

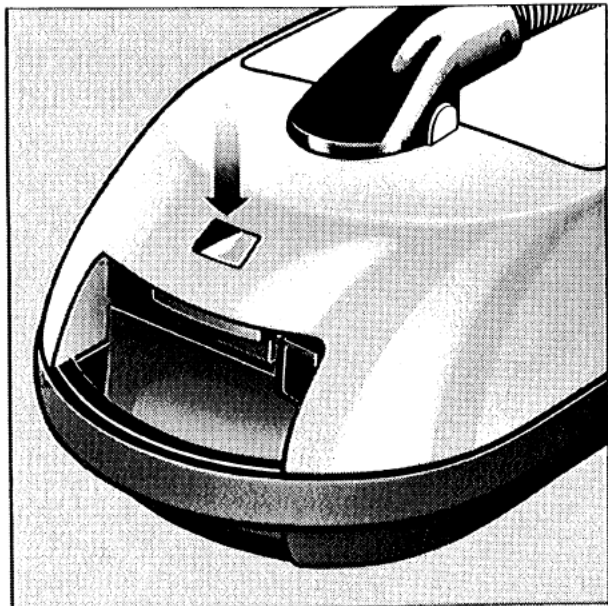

Dustbag change indicator

This indicates when the dustbag needs changing.

- Set the suction power selector to maximum.
Switch on the vacuum cleaner and lift up the floor nozzle so that it is not resting on the floor. If the red mark on the dustbag change indicator covers the window completely, change the dustbag, even if it does not seem completely full.

Please note:

The dustbag change indicator reacts to the air porosity of the dustbag. On the one hand, a small amount of cement, plaster or fine dust is enough to indicate a full bag, although the latter is almost empty. On the other hand, the bag can be full of carpet fluff and threads, although the indicator scarcely reacts. Such extremes seldom occur, as household dust is usually a mixture of carpet fluff, hair and sand. The MIELE dustbag change indicator is designed to react to such mixtures of dust.

We recommend the following:

1. When vacuuming a lot of sand and dust:

Change the dustbag, if the indicator shows "full".

2. When picking up a lot of fluff and hair, the indicator will show the dustbag as only "half full", when it is actually bulging.

Important: Nozzles, such as the crevice nozzle, affect the function of the dustbag change indicator. Therefore, only attach the **floor nozzle** when checking whether the bag is full.

Transport & storage

During transportation, when not in operation and during storage:

- Place in a vertical position.
- Push down the retractable wand holder on the telescopic suction wand and insert into the vacuum cleaner.

The wand holder can be moved as desired.

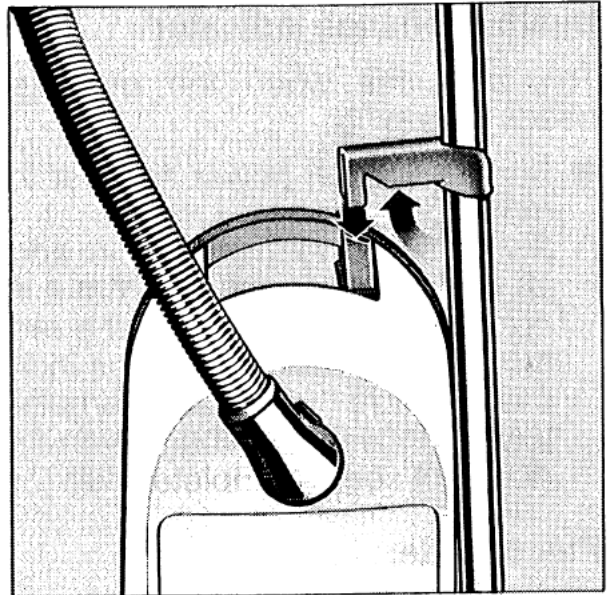

Park System

A Park System has been designed for conveniently parking the vacuum cleaner during pauses. A special parking attachment is fitted to the floor nozzle and to the nose of the cleaner.

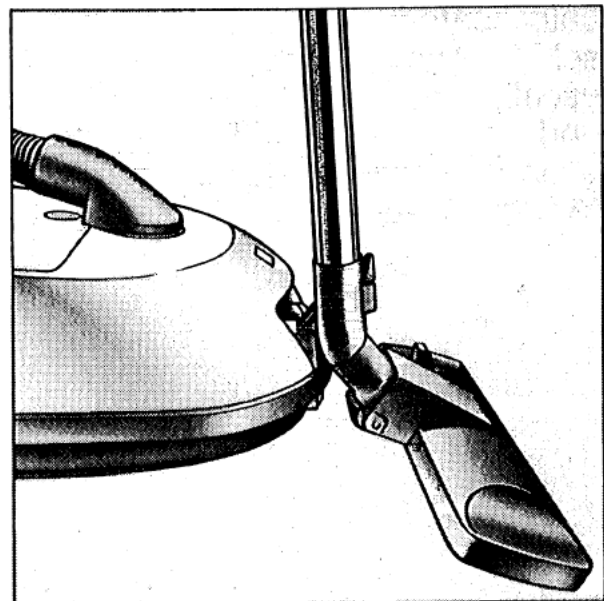

The vacuum cleaner is fitted with three filters which must be replaced regularly in order to guarantee proper suction efficiency:

- Dustbag (paper filter bag)
- Dust compartment filter
- Exhaust filter (Miele Super Air Clean filter)

Replacement filters can be obtained from your local MIELE dealer.

Use only genuine Miele filters and dustbags, making sure they are the correct ones for your vacuum cleaner model. Always state the part number of the bag, with designation **H**, and the model number of the cleaner when ordering new dustbags.

Change paper dustbag:

when the indicator shows the bag is full, or under the conditions described on page 16.

Change the exhaust filter (Super Air Clean Filter)

Each time you start a new packet of Miele paper filter bags.

Change the dust compartment filter

The dust compartment filter should last a long time and only needs to be changed if it gets very dirty. This may happen if, for instance, the dust bag is damaged and leaks.

Changing the filters

Open the dust compartment lid as follows:

With the machine lying flat lift lid catch and raise dust compartment lid until it clicks into place.

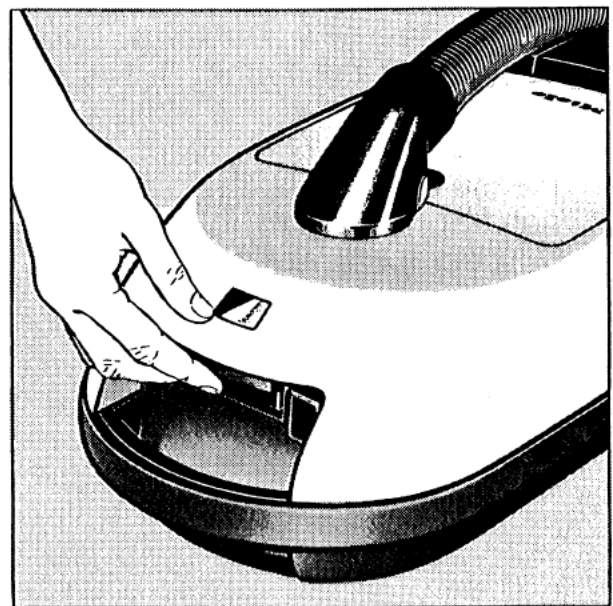

Maintenance

Replacing the paper dustbag

The paper dustbag has a closing flap which closes automatically when the dustbag is removed to prevent any dust escaping.

- To remove the dustbag grasp the card collar by the two finger holes and pull it out. It can then be disposed of with the normal household waste as long as it has only been used for vacuuming up normal household dust.

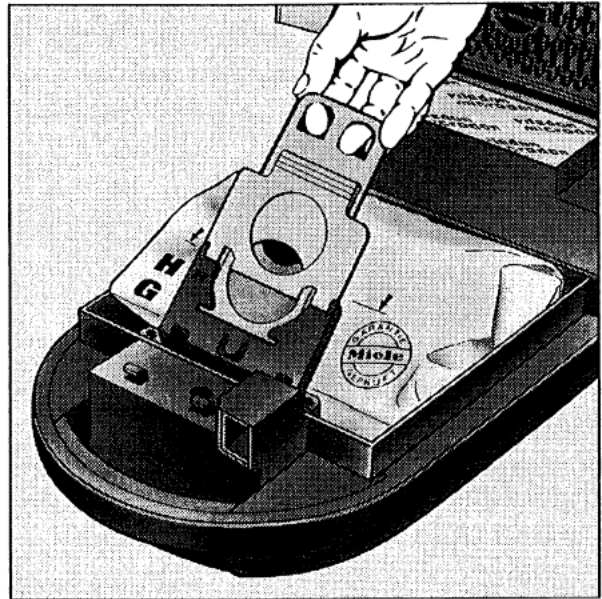

- Place the new dustbag collar securely in the frame. If it is not correctly located the dust compartment lid will not close. Please ensure that the dustbag is not trapped when the lid of the dust compartment is closed.

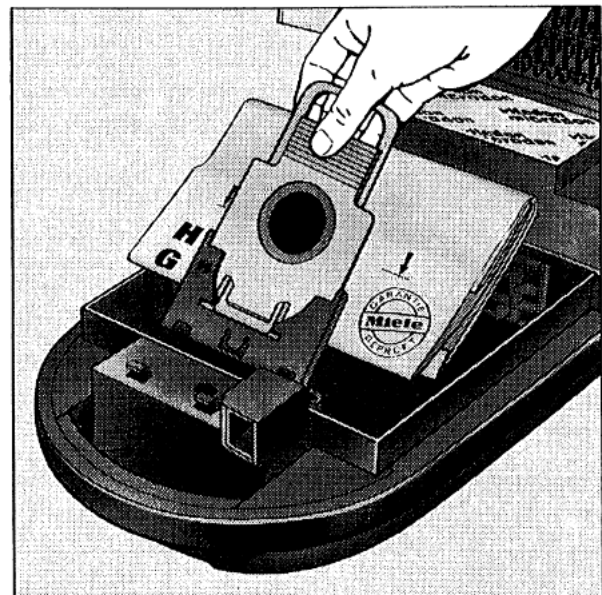

To change Dust Compartment Filter

The dust compartment filter is a small black filter on the bottom right-hand side of the compartment. To change:

- 1) Open the frame.
- 2) Remove old filter and discard.
- 3) Place new filter onto frame.
- 4) Flip frame back into place until it clicks.

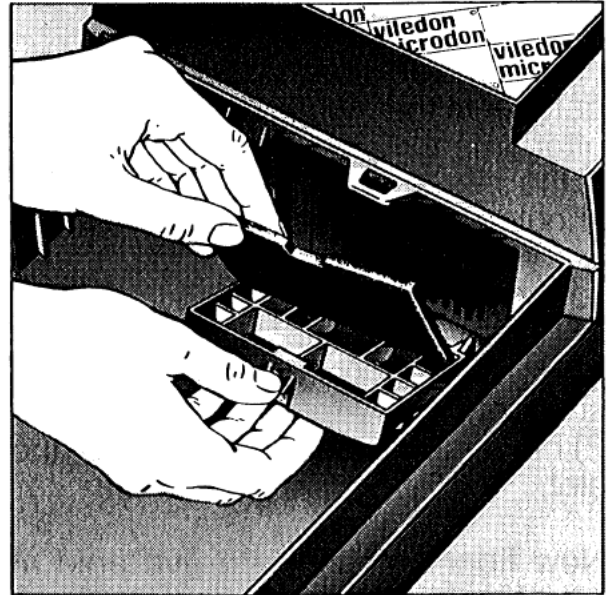

Exhaust filter (MIELE SUPER AIR CLEAN particle filter)

Change the MIELE SUPER AIR CLEAN particle filter every time you open a new pack of vacuum cleaner dustbags.

A Super Air Clean Filter is included in every pack of Miele dustbags.

To remove the used super air clean filter from the filter frame grasp the filter by the clean, unsoiled section (see arrow in diagram).

Take it out and replace it with a new one. It can be inserted either way up.

- Close the filter frame firmly.

New MIELE SUPER AIR CLEAN filters can also be obtained from your Miele dealer.

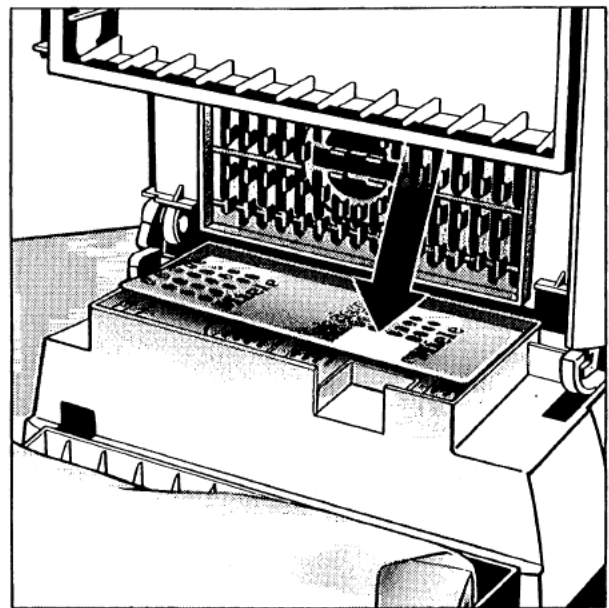

Maintenance

Changing the fiber catcher

From time to time inspect the fiber catcher in the mouthpiece of the floor attachment.

If the pile is worn, the fiber catcher should be replaced.

To replace:

- 1) Remove the worn fiber catcher from its slots using a dull knife or screwdriver.
- 2) Fit a new fiber catcher into the slot.

New fiber catchers are available at your local Authorized Miele Dealer.

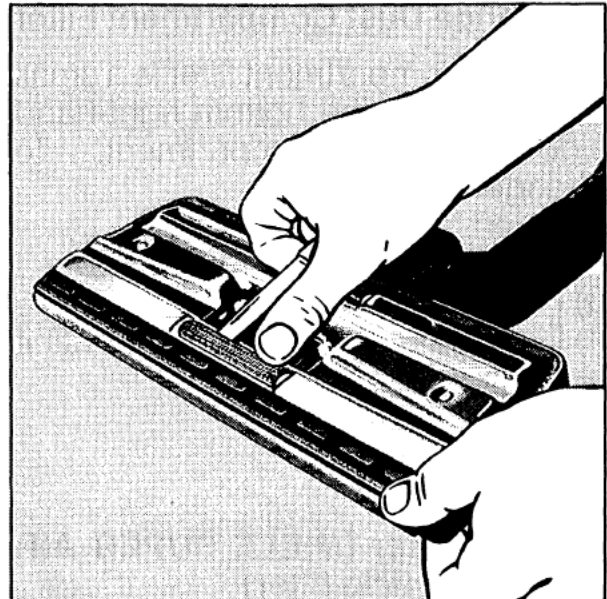

Servicing the floor roller

Occasionally hair, lint and fluff will become trapped in the roller of the floor attachment.

To remove this material:

- 1) Lift up on axle handle.
- 2) Slide out axle.
- 3) Lift out roller.

Remove any foreign material; after cleaning the roller, replace by reversing the above process.

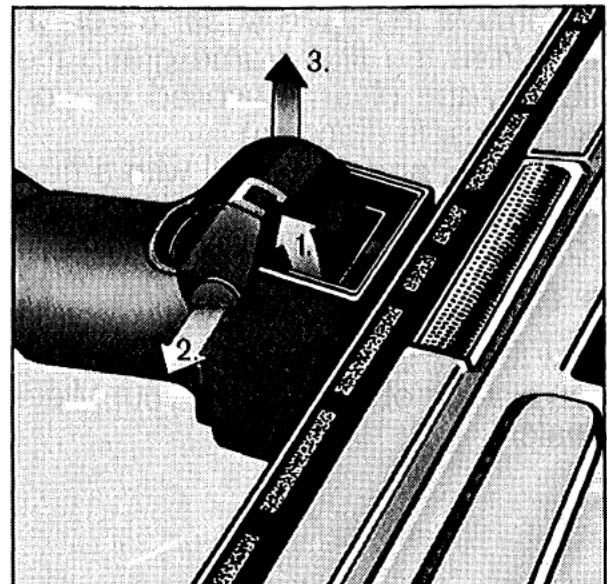

- Connect the vacuum cleaner only to a 120 V/60 Hz, 10 or 15 A fused receptacle.

General Care

The vacuum cleaner and all attachments can be cleaned with a damp cloth or with a mild plastic cleaner. The electro suction wand should not be immersed in water.

The dust compartment can, if necessary, be cleaned using a dry duster, dusting brush or, if available, by using a second vacuum cleaner to suck or blow the dust out.

Miele®

MIELE APPLIANCES, INC.
22 D Worlds Fair Drive
Somerset, NJ 08873
Tel. No. (908) 560-0899
Fax: (908) 560-9649